

ZEVO MAX II

BY OPTICLIMATE



INSTALLATION & USER GUIDE

Engineered & Designed in Holland

www.opticlimate.com



PLEASE READ THE FOLLOWING INFORMATION CAREFULLY BEFORE USING THE UNIT:

- High Temperature Safeguard on **page 7**
- Delete alarm history on **page 12**
- Dehumidify without cooling pro4 on **page 12**

**THE FUTURE OF COOLING
JUST GOT COOLER.**

INSTALLATION

Installation

Installation spacing

To guarantee proper air suction, leave at least 15cm of space between the wall and the backside of the unit, where the carbon & dust filters and air inlet are located. At least 15cm of space should also be left between the topside of the unit and the ceiling. Larger spaces are preferred. The unit must stand free from the wall to avoid contact noises.

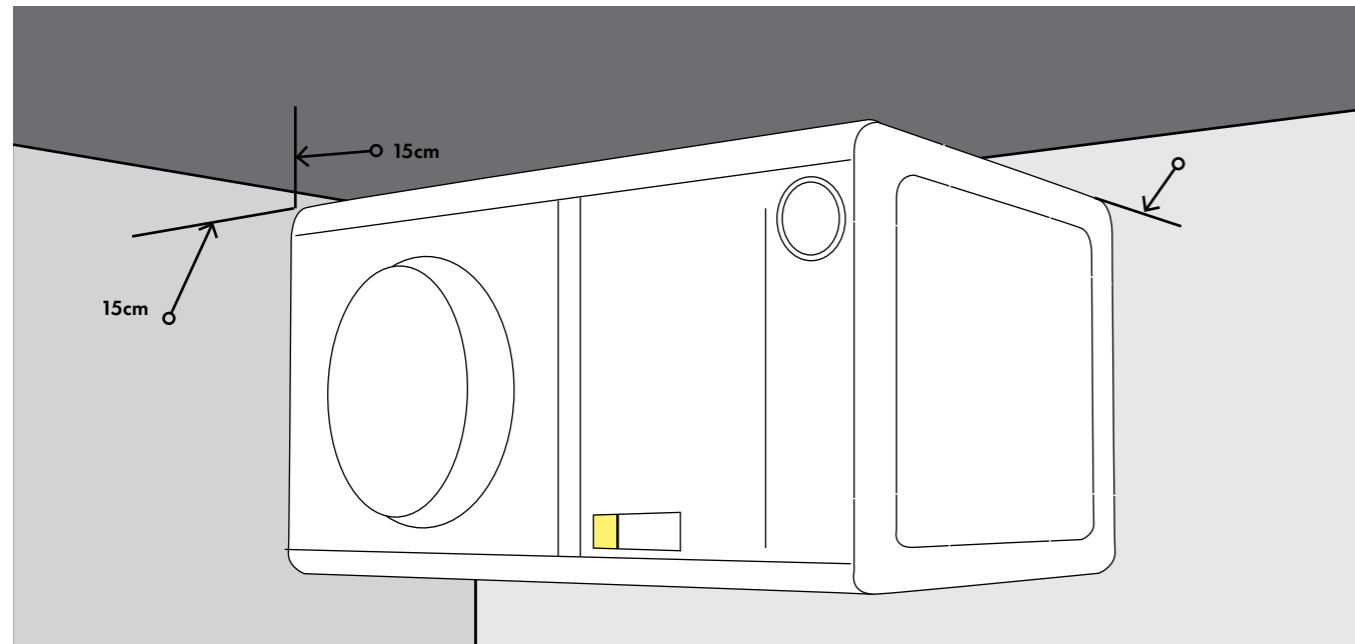

Installation

The unit can be hung from a ceiling or placed on a stand or frame.

Ceiling

To hang the unit from a ceiling, remove both side panels and pinch a hole through the insulation at the position of the 4 holes in the bottom of the unit. Use an M8 or M10 metal threaded rod with a nut, washer and rubber damper to prevent unwanted noise or vibration.

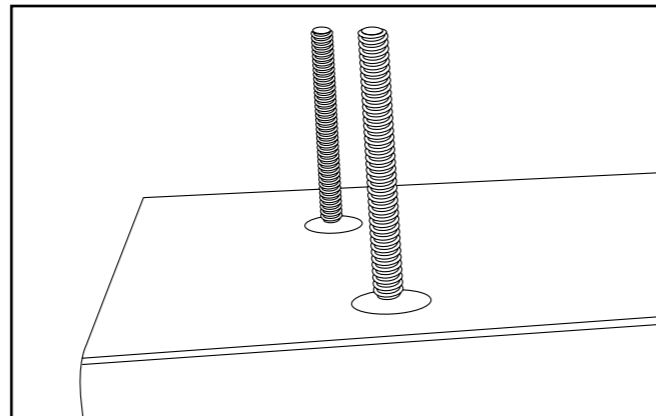
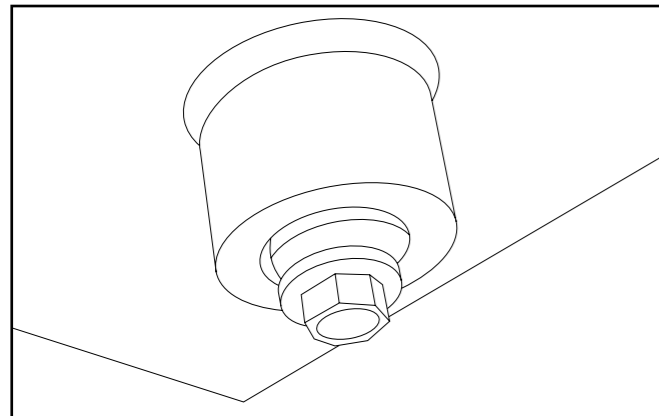

INSTALLATION

Stand or frame

Make or buy a stand or frame to hold the weight of the Opticlimat. (see nameplate)

You can use the rubber damper or a vibration damper (not included)

Pinch a hole through the insulation at the position of the 4 holes in the bottom of the unit. Use an M8 bolt and washer to mount the rubber or damper.

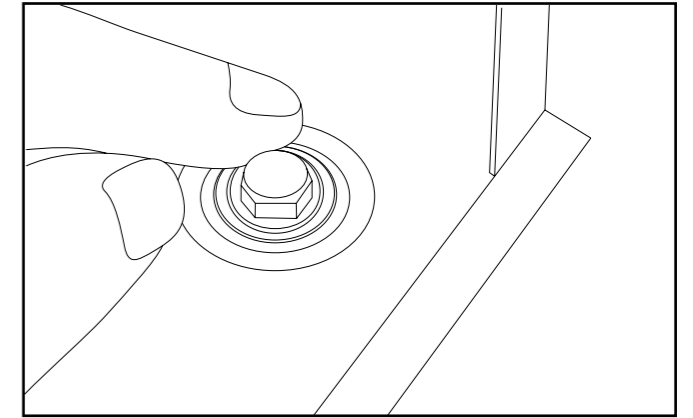
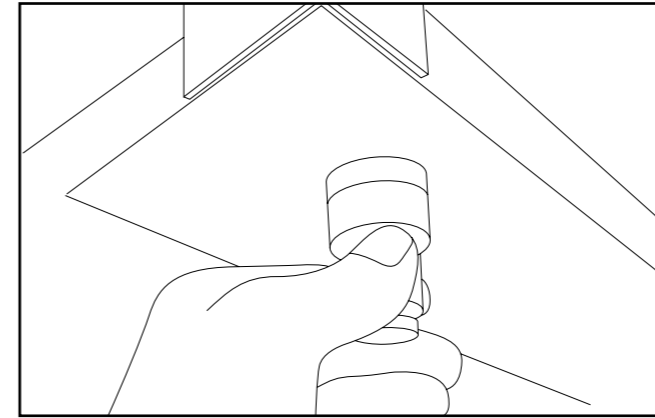

Make sure the side of the condensation outlet is 1 cm lower than the opposite side.

Routing the Cables

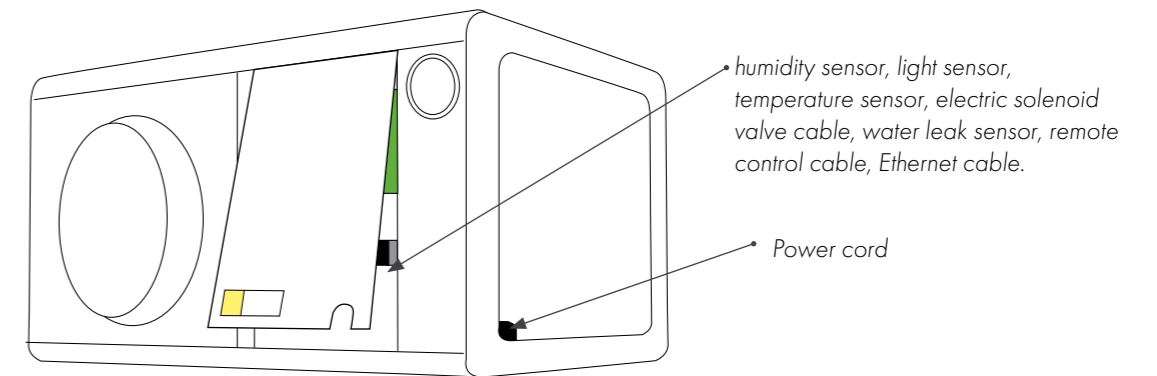

First, the panel at the left side near the manometer should be removed to make the various electrical connections. A magnetic valve, water leakage sensor, automatic moisture meter, remote control and room

temperature sensor are supplied with the unit. Their cables can be led to the outside through the opening at the bottom of the panel. The power cable for the power supply can be led through the black feed-through rubber at the side of the unit.

ELECTRICAL CONNECTION

Electric solenoid valve

The plug of the solenoid valve should be connected using the black cable supplied with the unit, as shown in the illustration below.



The other end of the cable is connected to the circuitboard (see picture). The third connection of the solenoid valve can be used as earthing.

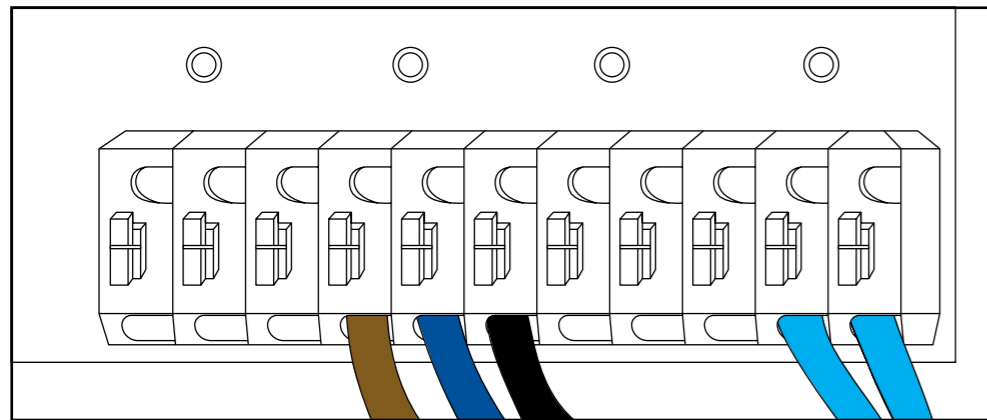

Water leakage sensor

The connection set contains a loose, 5m long white wire: the water leakage sensor. This sensor is connected to the terminal on the printed circuit-board. The sensor cable should be led to the outside through the opening in the panel and should be placed on the ground at the lowest point. The end of the sensor cable can be split into several cores using a connector, so that more than one point is secured against leakage.

If the sensor has a black cap, this should be cut back and stripped 5mm and the cores should be stripped. Connect the other side to the little white plug on the printed circuit-board as shown in the illustration. In case of water leakage, the water supply will be stopped immediately by means of the electrical valve in the water pipe.

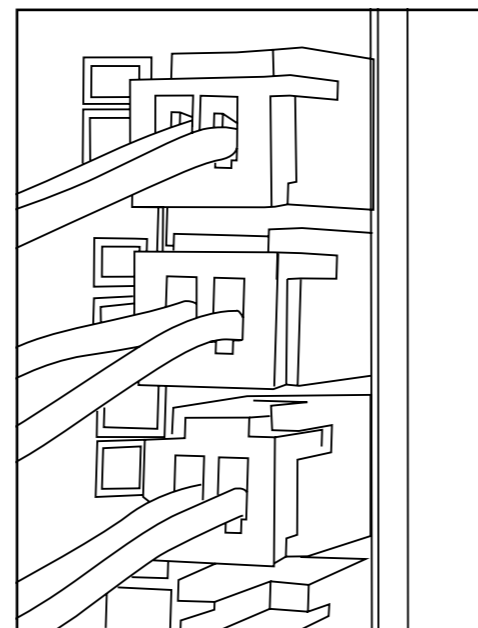

ELECTRICAL CONNECTION

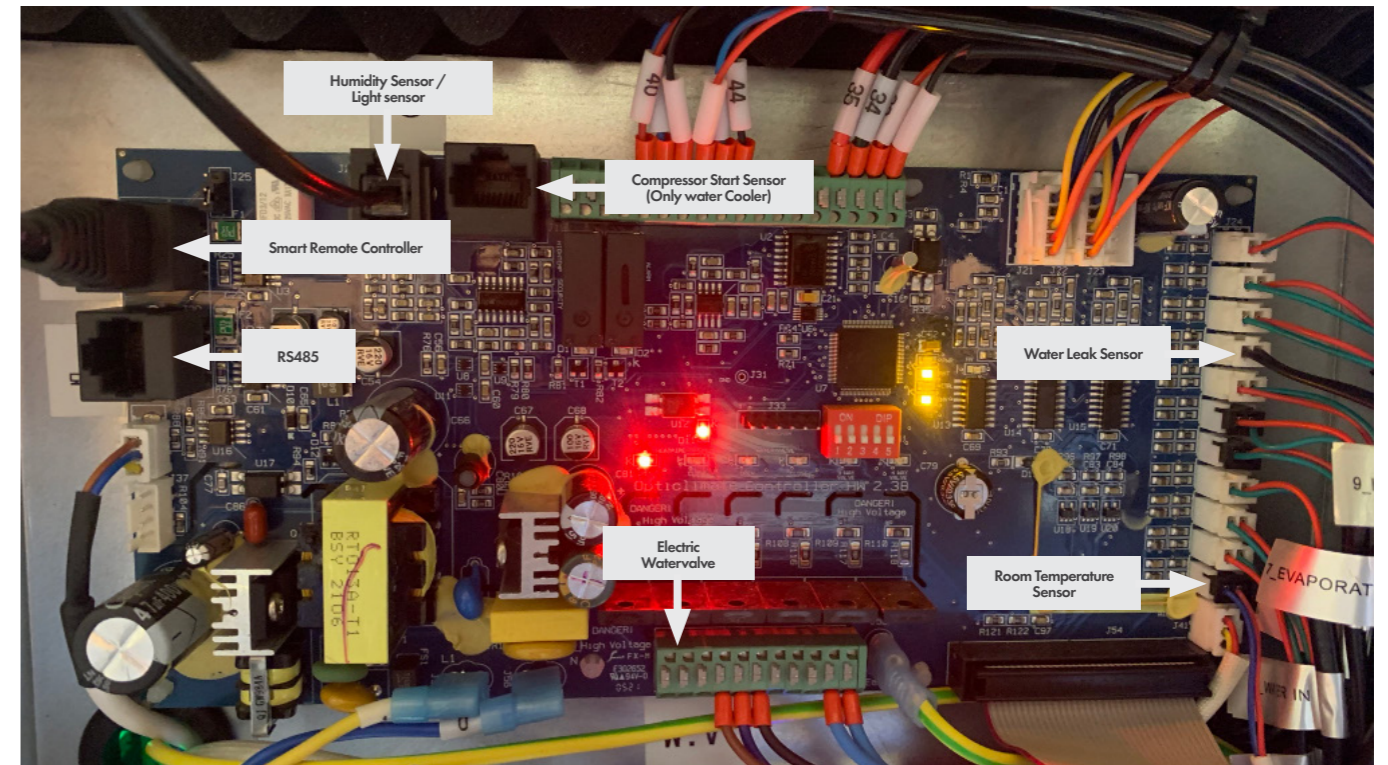

Automatic Humidity Sensor with light cell

The automatic moisture meter with built-in light cell supplied with the unit is already connected. The cable should be led through the opening in the panel. The automatic moisture meter should be hung in the room and may NOT be covered. The light cell in the automatic moisture meter automatically switches the OptiClimate from day to night mode.

Room temperature sensor

The compartment also has a room temperature sensor, which is already connected to the printed circuit-board. This sensor should be led to the outside through the opening in the panel and should be hung at the level of the upper side of the vegetation. The sensor should be protected against heat radiation but must be put in the shade. A protective cover over the sensor is sufficient.

The Smart Remote Controller

The remote control contained in the compartment can be hung in the room but can also be hung elsewhere. This way the OptiClimate can also be controlled from outside the room. The four-remote cable is already connected and should be led to the outside through the opening in the panel.

POWER SUPPLY SPECIFICATIONS

Power supply specifications

| Model | 6000REV01 | 6000REV02 | 10000REV01 | 10000REV02 | 15000REV02 | 20000REV02 |
|-------------------|-----------|-----------|-----------------------------|------------|------------|------------|
| MCB 1phase | | | 1PH+N 40A type C | | | |
| MCB 3phase | | | 1PH+N 40A type C | | | |
| Cable size 1phase | | | 3x6mm ² stranded | | | |
| Cable size 3phase | | | 5x4mm ² stranded | | | |

4 different OptiClimate models are available. For your safety and the safety of the OptiClimate, the following specifications should be observed when connecting the power supply: use the circuit breakers (MCB) and cable thickness specified.

The cables for the supply voltage should be led through the grommet at the side of the unit and connected to the green screw terminal on the circuitboard as described in the illustration. The grounding can be connected to the PE at the bottom right of the metal back plate.

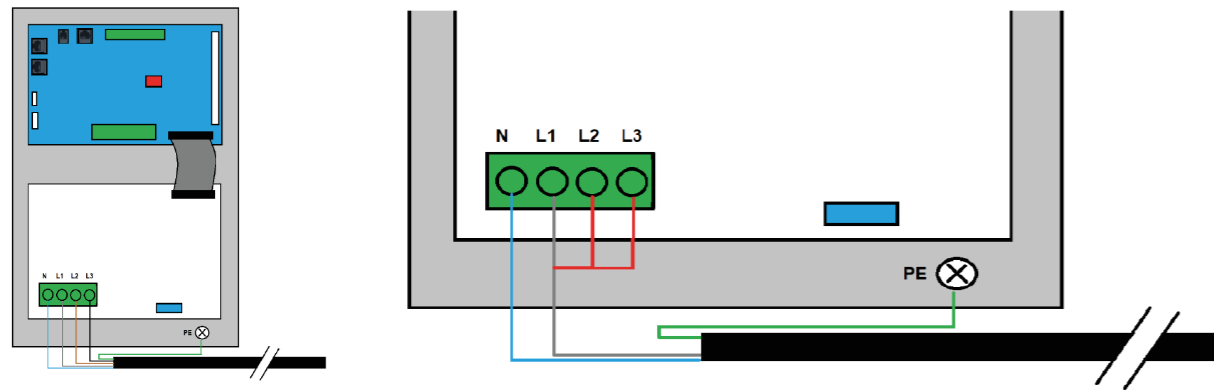

When it's not possible to use a 3 phase power supply but only a single phase power supply is available the phase L1 + L2 + L3 need to be looped using a correct diameter wire. (only 6000 and 10000 models)

POWER SUPPLY SPECIFICATIONS

High temperature safeguard

Using this safeguard, the OptiClimate can switch off the heat sources (e.g. lamps) when the temperature in a room becomes too high. The unit has a terminal that can be connected to the timer of a control panel, for example.

The feed wire running to the switch in the timer should be interrupted for this purpose. Terminal 1, for example, is for a Grasslin clock and terminal 4 for a LeGrand timer.

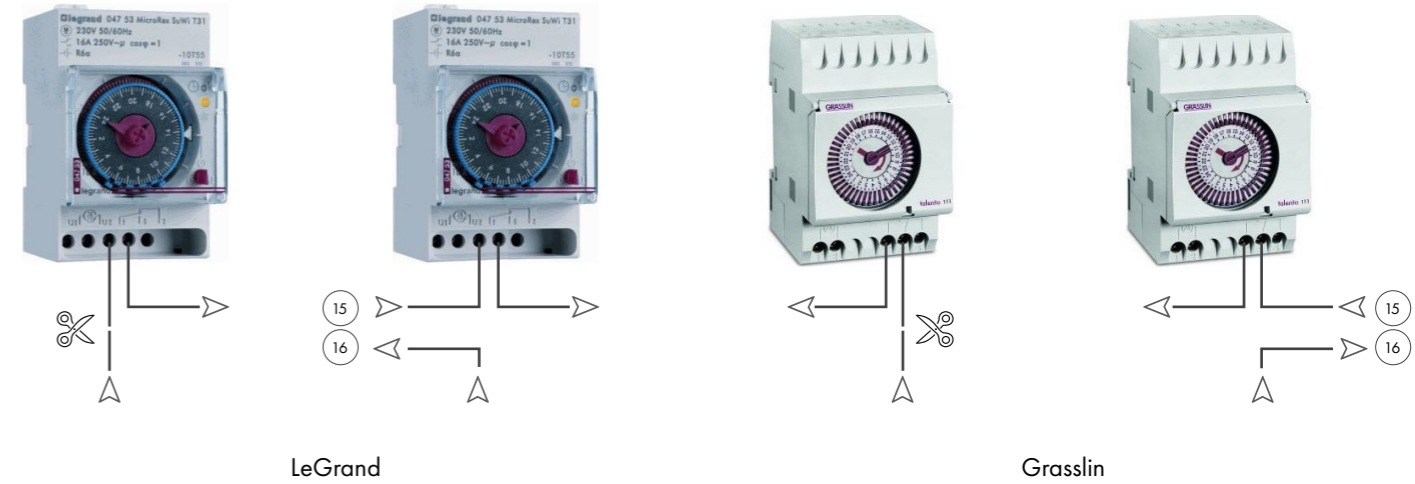

The two ends should be connected to terminals 15 & 16 on the terminal strip in the electrical compartment of the OptiClimate. The OptiClimate supplies the power for the timer.

The OptiClimate supplies the power for the timer. If the room temperature exceeds 35°C, the OptiClimate will interrupt the circuit, switching off the heat sources. **ERROR 15** is then displayed on the remote control.

Always refer to the timer manufacturer's manual if a model other than the one shown is used.

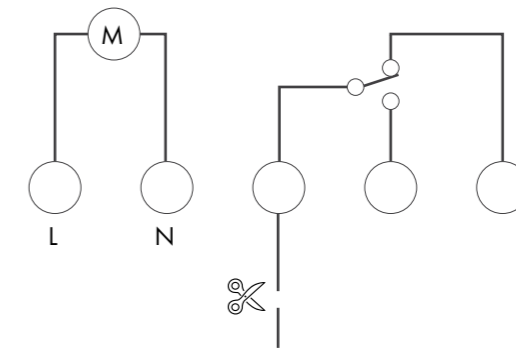

TEMPERATURE SAFEGUARDS

Water-in and water-out connections of the cooling water.

The unit can be used by connecting the water in and out connections to a cold water supply and a drain or can be used using the Opticlimate water cooler to cool the water in a closed loop. (connections and discription of a water cooler setup need to be obtained in the water cooler manual. Only the setup using a cold water supply and a drain are discribed in this manual.

Using a water cooler or other closed loop systems skip to page *

The unit has a water inlet and outlet. The inlet needs to be connected to a cold water supply (max 25°C) with a solenoid valve installed at the beginning of the piping going to the Opticlimate water-in connection. In case of a waterleak the valve will close. Mounting the valve at the end of the piping (near the Opticlimate) is pointless. (always check the flow direction arrow on the valve!). Make sure that the black magnetic coil of the solenoid valve is positioned upwards (preferred) or to the side. If it is positioned downwards, condensate from the cold valve might enter the coil. Make sure that the solenoid valve is installed at a fixed point that is always easily accessible to the user.

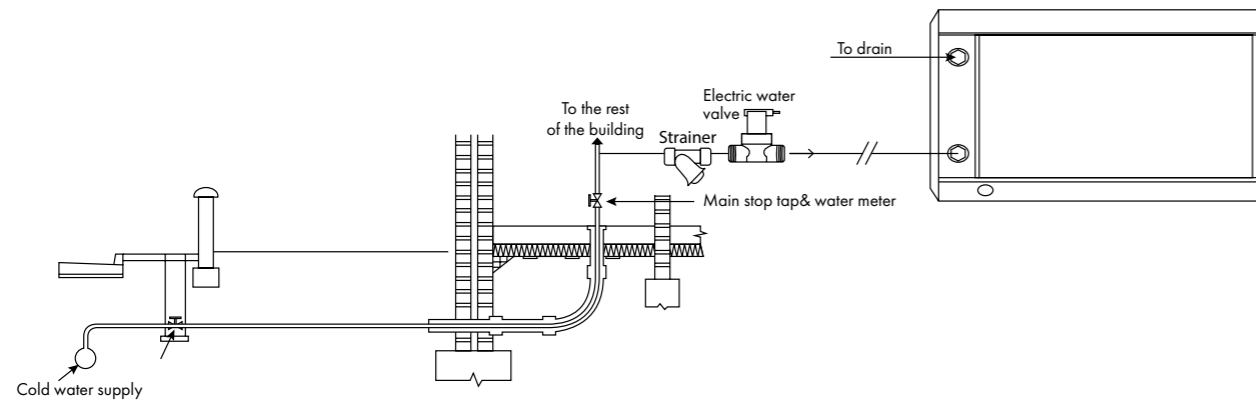

A strainer should be placed in the water inlet. This strainer prevents blockage in the heat exchanger inside the unit. It is recommended to insulate the cold water supply line in order to prevent condensation build-up. The upper water connection is the water-outlet. The water-outlet can be connected directly to the drain (sewer). Alternatively, the warm water can be used for heating purposes. The water is aprox 35°C- 40°C.

The water flow (water usage) is automatic regulated by an electronic flow regulator inside the unit.

When you use an alternative cold water supply such as a well or water from a river, leak or pond, make sure the water is filtered and clean the heat exchanger on regular basis. Contact tech support for more information regarding cleaning the heat exchanger.

WATER-SIDED CONNECTIONS

Discharge of the condensation water

The unit will dehumidify the air during cooling and in dehumidify mode. The moisture extracted from the air is collected in the condensation pan. The condensation pan has an 3/4 drain pipe where the condensate will run off. The condensate can be used as irrigation water. The cooling block has been modified to prevent metals or oxides from entering the condensate water.

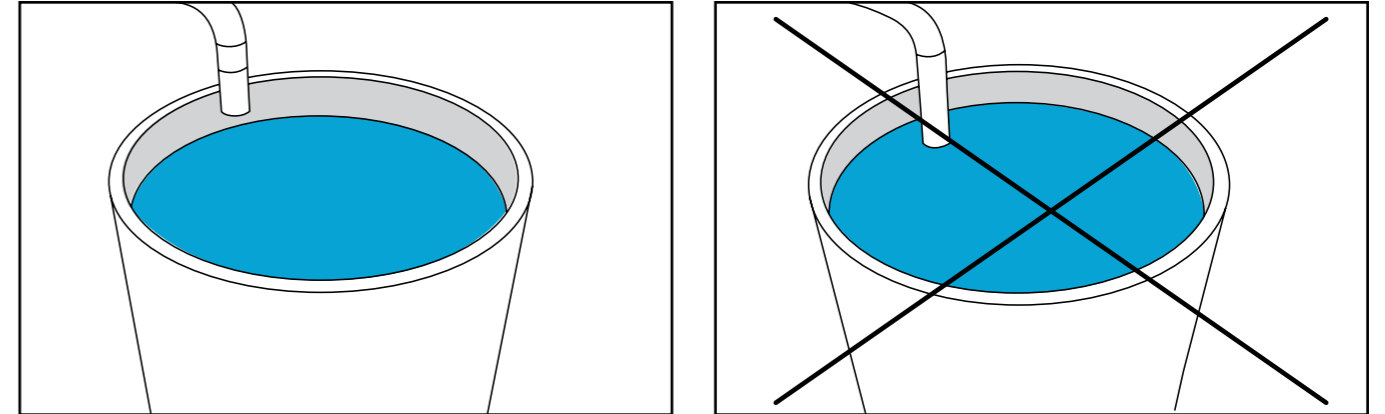

The location of the drain pan is on the negative pressure side of the unit, meaning that air can enter into the unit through the condensation drain. It's highly recommended to use a "P-trap" on the condensation outlet to prevent air entering the unit and to prevent condensate run-off problems. Not using a p trap also results in loss of capacity and bypassing non processed air.

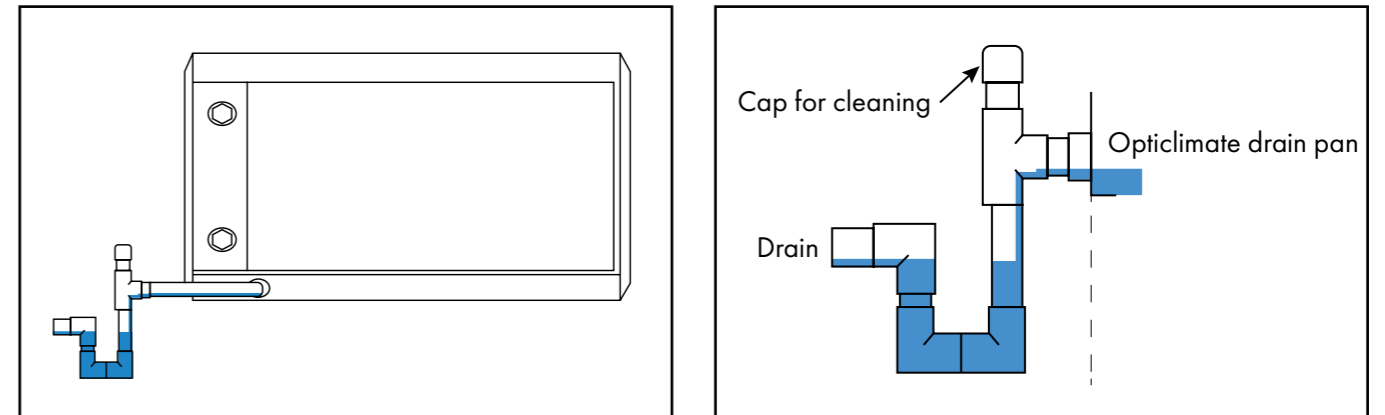

Drain pump of the condensation water

incorrect drain installation

If the unit is installed at the same level or lower than the drain or sewer, a condensation lift pump can collect the water. This small lift pump pumps the water through a hose of 9mm to a height of 4 metres into the drain or collecting tank. Stronger pumps are also available.

WATER-SIDED CONNECTIONS

Connecting the Smart Remote Controller



Power

Connect the power supply and USB connector from the remote cable to the Smart Remote controller.



Power

Connect the power supply and USB connector from the remote cable to the Smart Remote controller.

SMART REMOTE CONTROLLER

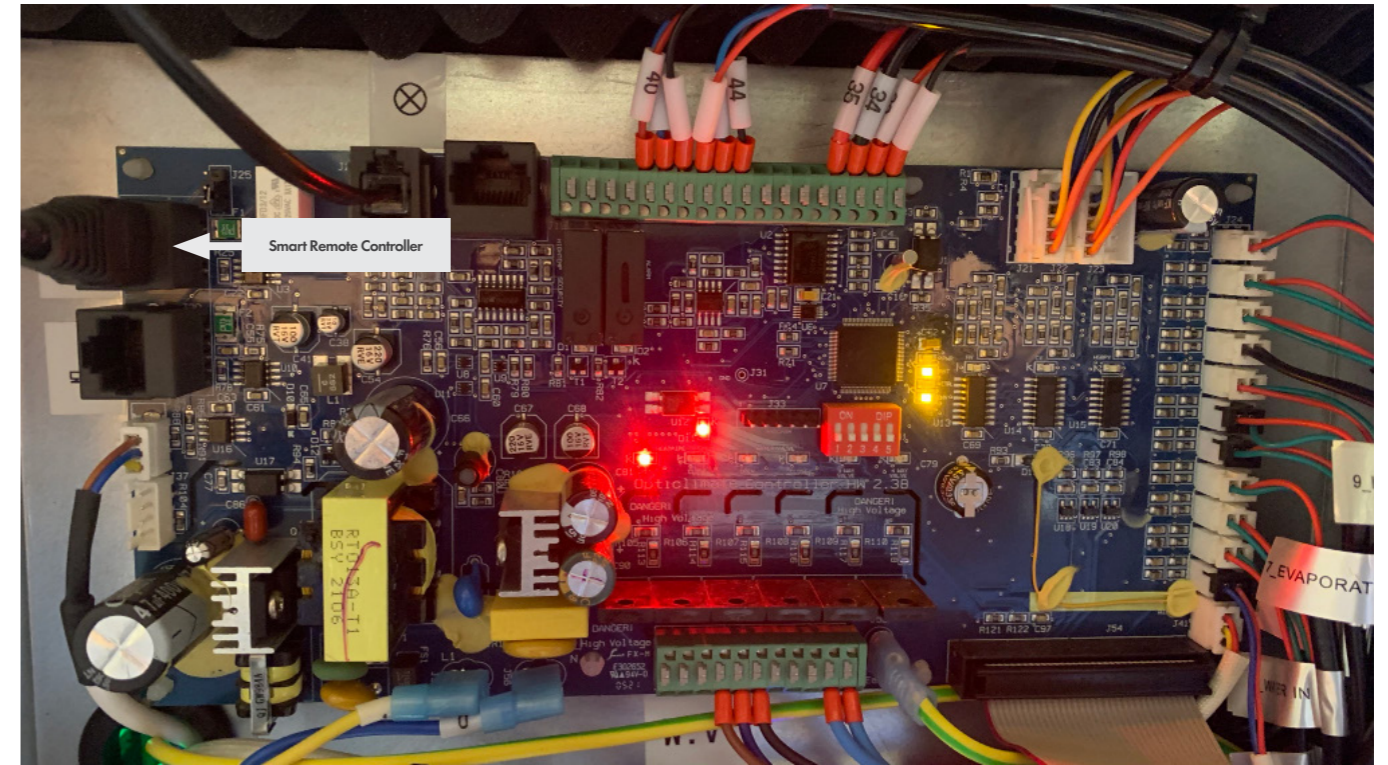

Connect the RJ45 side of the remote control cable to the RJ45 plug at the left upper corner of the circuit board (see image)

Powering up the unit

- Power on the Smart Remote Controller
- Power on the Opticlima by switching on the power supply.
- Open the water supply.

After powering up the Opticlima, the unit will first initialize, this can take a few minutes.

All valves and sensor are tested prior to startup. The remote controller cannot be operated during initializing of the Opticlima.

After powering up the Smart remote controller, the remote will first initialize, this can take a few minutes. You will see several screens pop-up and close again, this is normal.

👍 The unit is now installed and ready to use

POWERING UP THE UNIT

After both Smart controller and Opticlimate are initialised, the Smart Remote controller will display the Home screen * 1

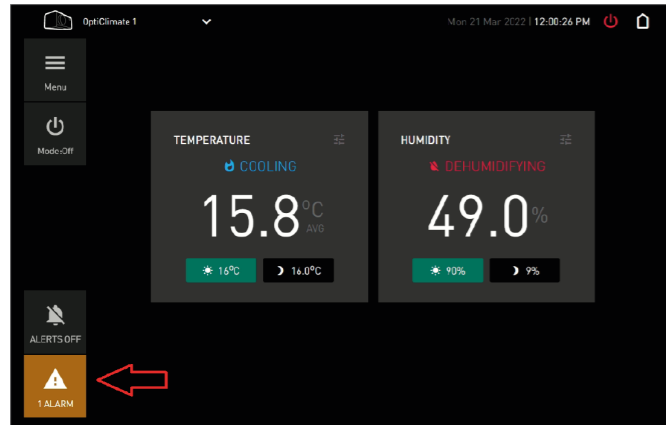

Alarm

The ALARM icon will display an alarm (power failure) this is normal after startup and will show each time you power up the unit or in the case of a power failure during initializing of the Opticlimate. After powering up the Smart remote controller, the remote will first initialize, this can take a few minutes. You will see several screens pop-up and close again, this is normal.

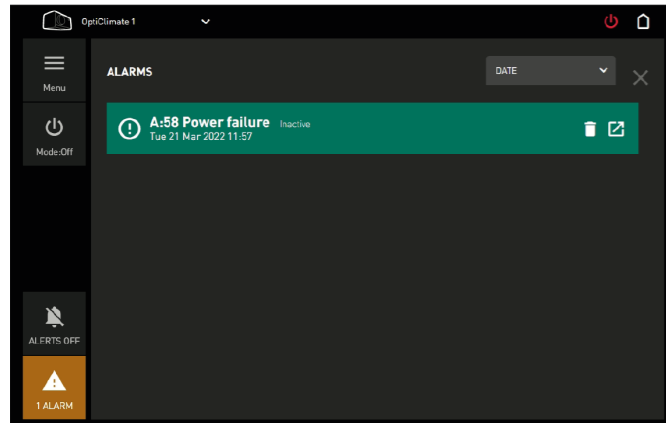

Reading and deleting the alarm

You can obtain more information regarding this alarm by pushing on the "enlarge button".

You can erase the alarm by pushing on the alarm icon and then press the bin.

In the right upper corner you find the home icon you can toggle between home 1 (basic) and home 2 (advanced)

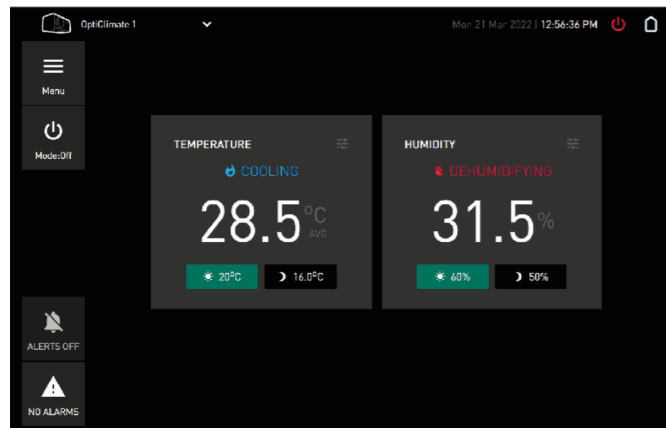

Homescreen 1

You can obtain more information regarding this alarm by pushing on the "enlarge button".

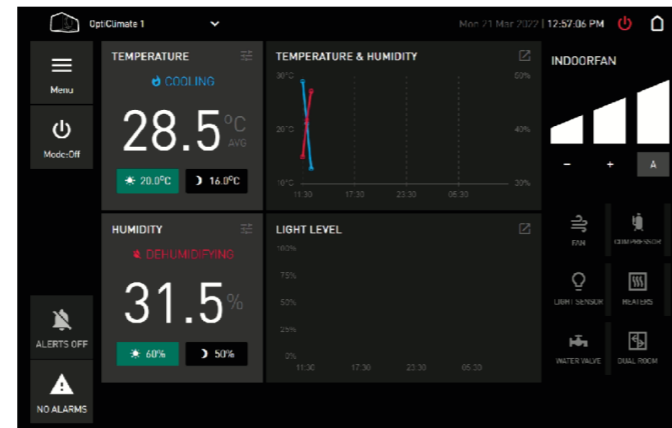

Homescreen 2

You can obtain more information regarding this alarm by pushing on the "enlarge button".

OPERATING BY USING THE SMART REMOTE CONTROLLER

Setting the basic parameters

Go to home 1 or home 2 by pressing the home icon.

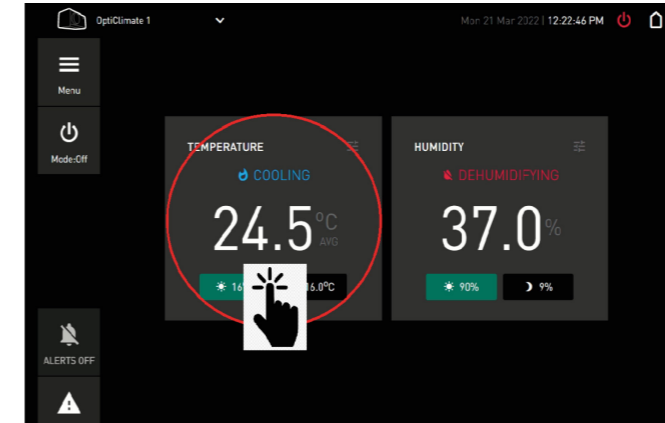

Setting day and night temperature setpoint.

Touch the Temperature area to enlarge the window for temperature day/night settings.

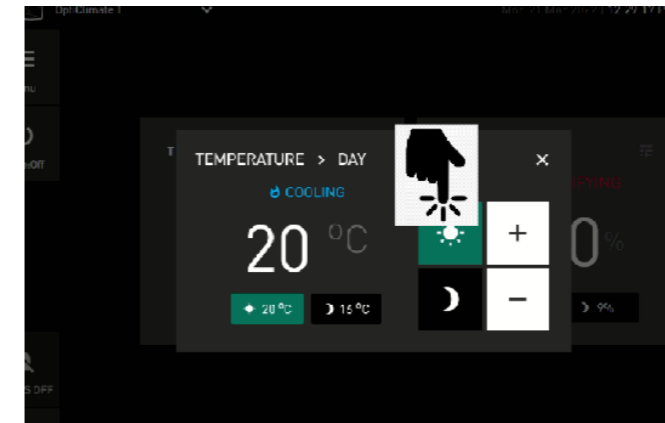

Setting day temperature setpoint.

Touch the sun icon to set daymode temperature and use + and - to change the daymode temperature.

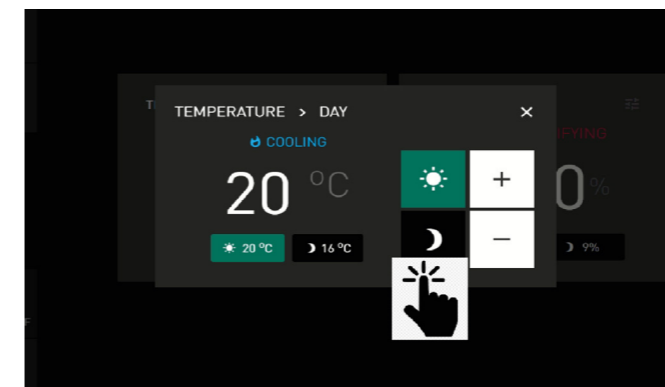

Setting night temperature setpoint.

Touch the moon icon to set nightmode temperature and use + and - to change the nightmode temperature.

Touch the X to return to home.

OPERATING BY USING THE SMART REMOTE CONTROLLER

Setting day and night dehumidify setpoint

Go to home 1 or home 2 by pressing the home icon.

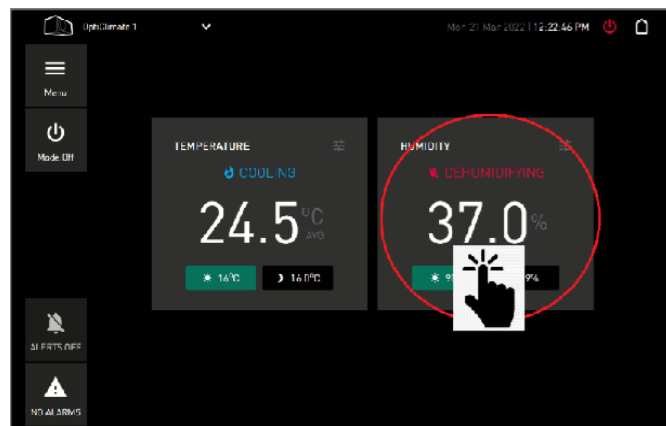

Setting day and night temperature setpoint.

Touch the dehumidify area to enlarge the window for dehumidify day/night settings.

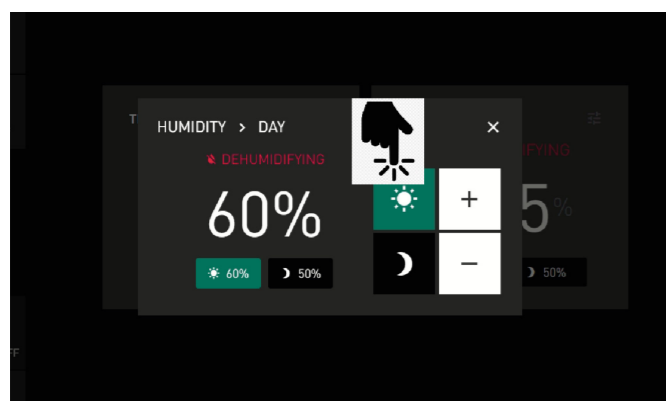

Setting day temperature setpoint.

Touch the sun icon to set daymode humidity and use + and - to change the daymode humidity setpoint.

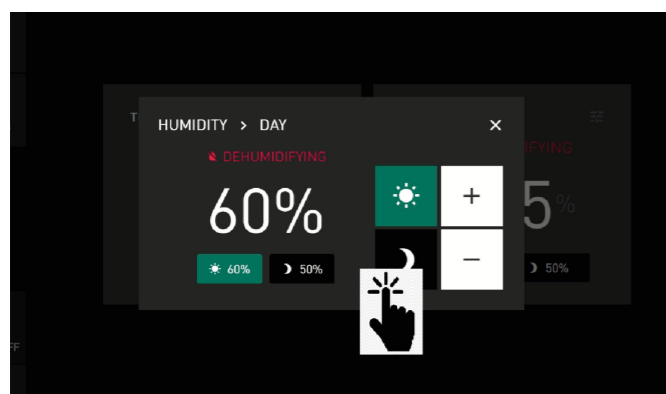

Setting night temperature setpoint.

Touch the moon icon to set nightmode humidity and use + and - to change the nightmode humidity setpoint.

Touch the X to return to home.

OPERATING BY USING THE SMART REMOTE CONTROLLER

Switching the unit on or off

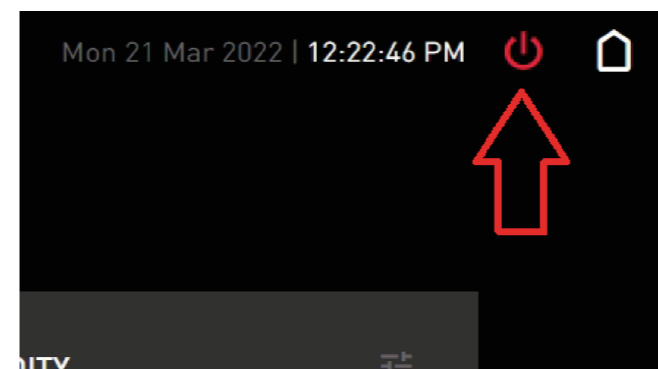

Setting day and night temperature setpoint.

In the right upper corner you find the on/off button. Touching the button will switch the unit on and the icon turns green.

Touching the button again will turn the unit off and the icon will turn red.

Sequens of operation when the unit is turned on.

- The on/off button turns green
- The fan inside the unit turns on.
- The light sensor will determine if the room is in day or nightmode.

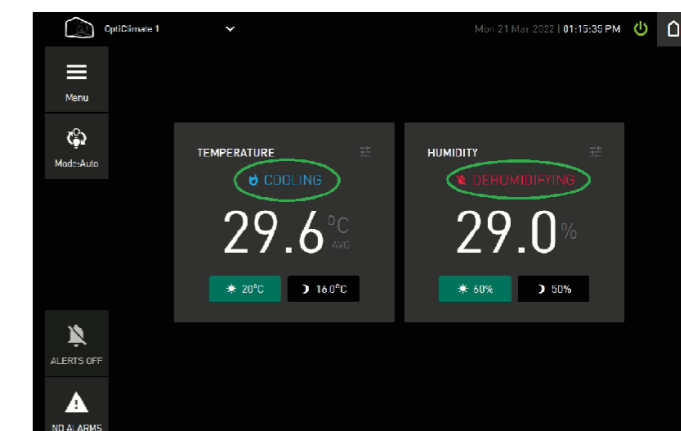
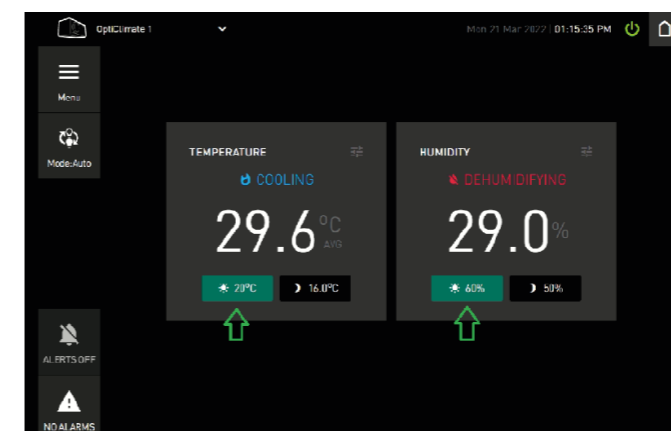

In daymode the windows with the sun turn green (night is black) and there will be an indication if the unit is cooling or not cooling and if there is a demand to dehumidify when not cooling. (Note: The unit always dehumidifies when cooling)

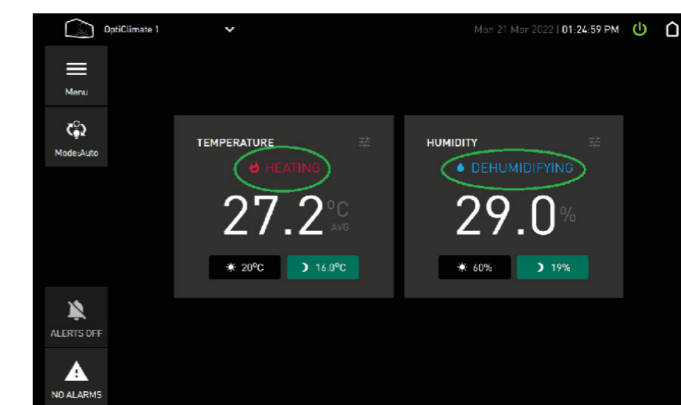
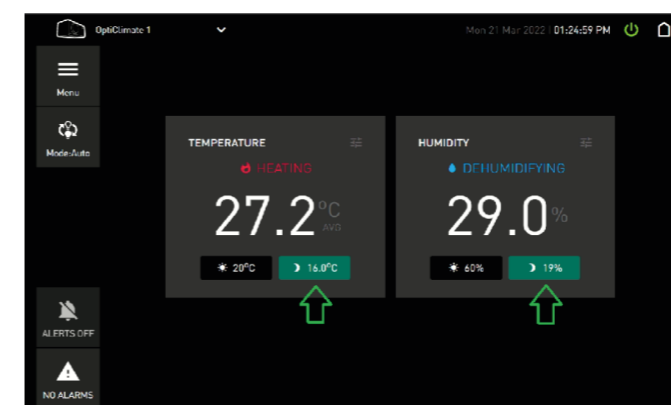

In nightmode the windows with the moon turn green (day is black) and there will be an indication if the unit is cooling or heating and if there is a demand to dehumidify when not cooling. (Note: The unit always dehumidifies when cooling)

OPERATING BY USING THE SMART REMOTE CONTROLLER

By touching the home button you can go to the advanced screen and you can see more parameters displayed and also a simple datalog window. The settings for temperature and humidity is the same as in the basic screen.

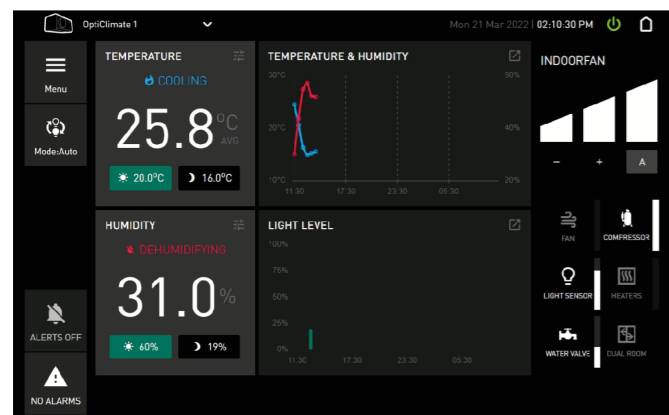

Home - Advanced Screen

By touching the home button you can go to the advanced screen and you can see more parameters displayed and also a simple datalog window. The settings for temperature and humidity is the same as in the basic screen.

For a more detailed manual of the Revomax Smart Remote controller use the qr code.

REVO MAX II

BY OPTICLIMATE

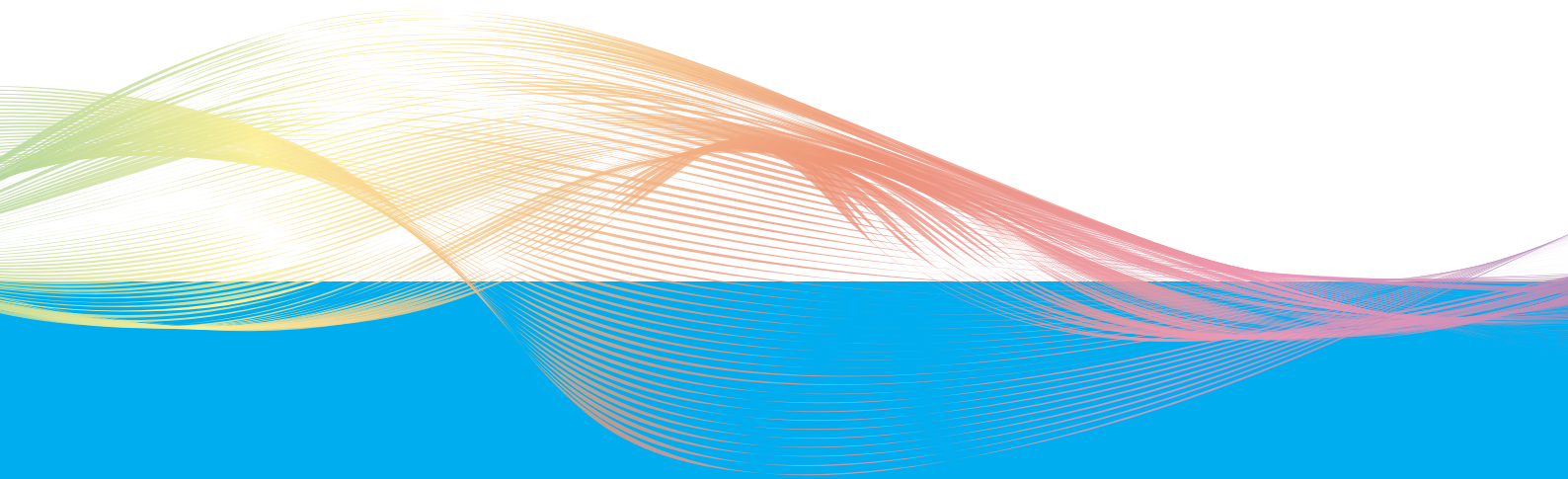

® Opticlimate is a registered trademark of
airsupplier

INSTALLATION & USER GUIDE

Engineered & Designed in Holland
Manual version 0113 2023

www.opticlimate.com

**THE FUTURE OF COOLING
JUST GOT COOLER.**